

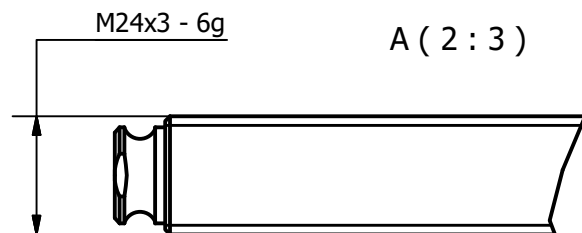

SIZE	-0030
PCLC	1404 mm
PIN / GAP	22.23 mm
BORE DIA	65 mm
ROD DIA	24 mm
STROKE	450 mm
WEIGHT	14.04 Kg
FULL BORE AREA (PUSHING/EXTENDING)	3318 mm ²
ANNULUS AREA (PULLING/RETRACTING)	2866 mm ²
OIL DISPLACEMENT (FULL BORE SIDE)	1.49 ltrs
OIL DISPLACEMENT (ANNULUS SIDE)	1.29 ltrs
MAXIMUM PUSH FORCE @ 5 BAR	169 Kg (1659 N)
PULL FORCE @ 150 BAR	4382 Kg (42989 N)
PULL FORCE @ 250 BAR	7304 Kg (71648 N)
MAX PULL FORCE @ 350 BAR (RELIEF)	10225 Kg (100307 N)

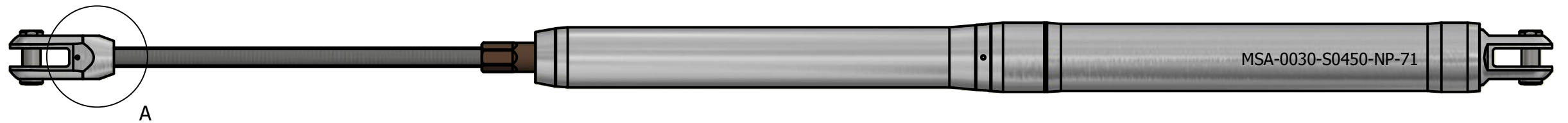
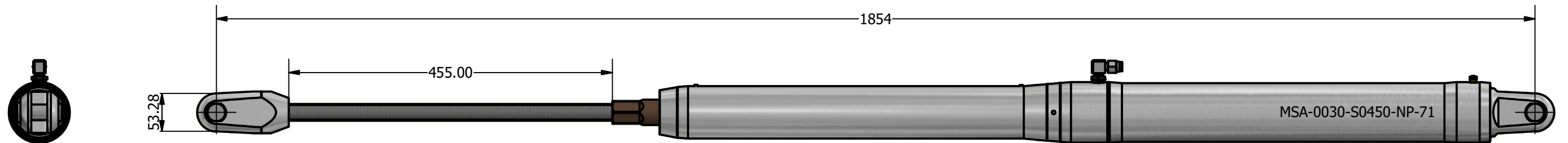
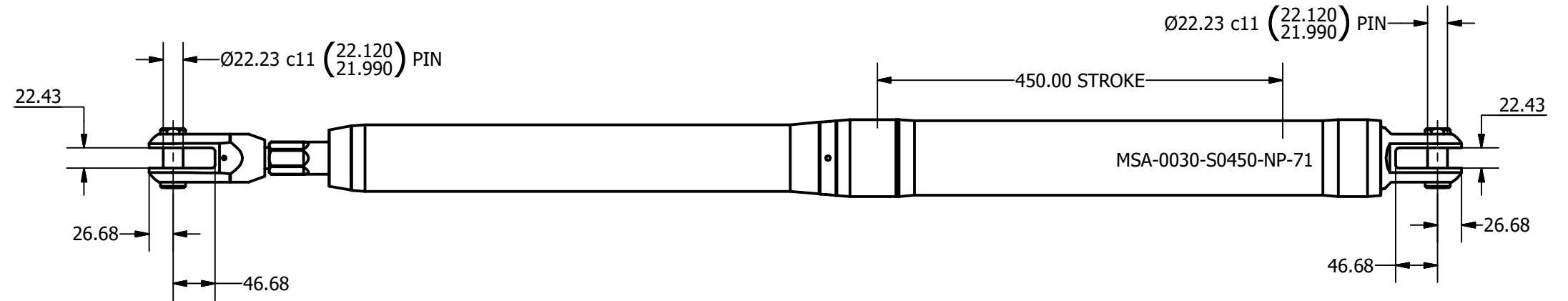
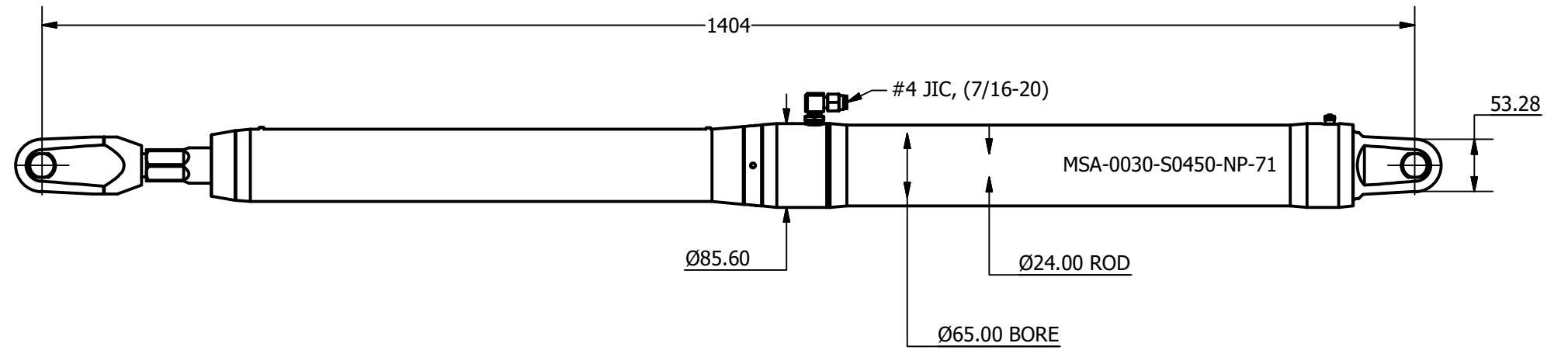

NOTE: CUSTOM STROKES, LENGTHS AND CLEVIS DIMENSIONS AVAILABLE UPON REQUEST

 Tel: +44 (0)1202 596600 www.oceanyachtsystems.co.uk	Title ALUMINIUM SINGLE ACTING MECHANICAL LOCK CYLINDER		Revision 1	Dimensions in millimeters & degrees Gen. Tolerance ± 0.25 Gen. Finish 3.2		
	Drawing No. MSA-0030-S0450-NP-71		Material	Finish ANODISE BLACK		 If in doubt ask!
	Sheet 1 of 1	Scale 1:6 @ A3	Mass N/A	Date Drawn 23/04/2018	By A.N.	
© Copyright. All rights to this drawing and design are the sole property of Ocean Yacht Systems Ltd. This drawing must not be copied, communicated or loaned to any third party without the written consent of Ocean Yacht Systems Ltd.			Mat. Cert.	Insp. Lev. III	Fin. Lev. A	