

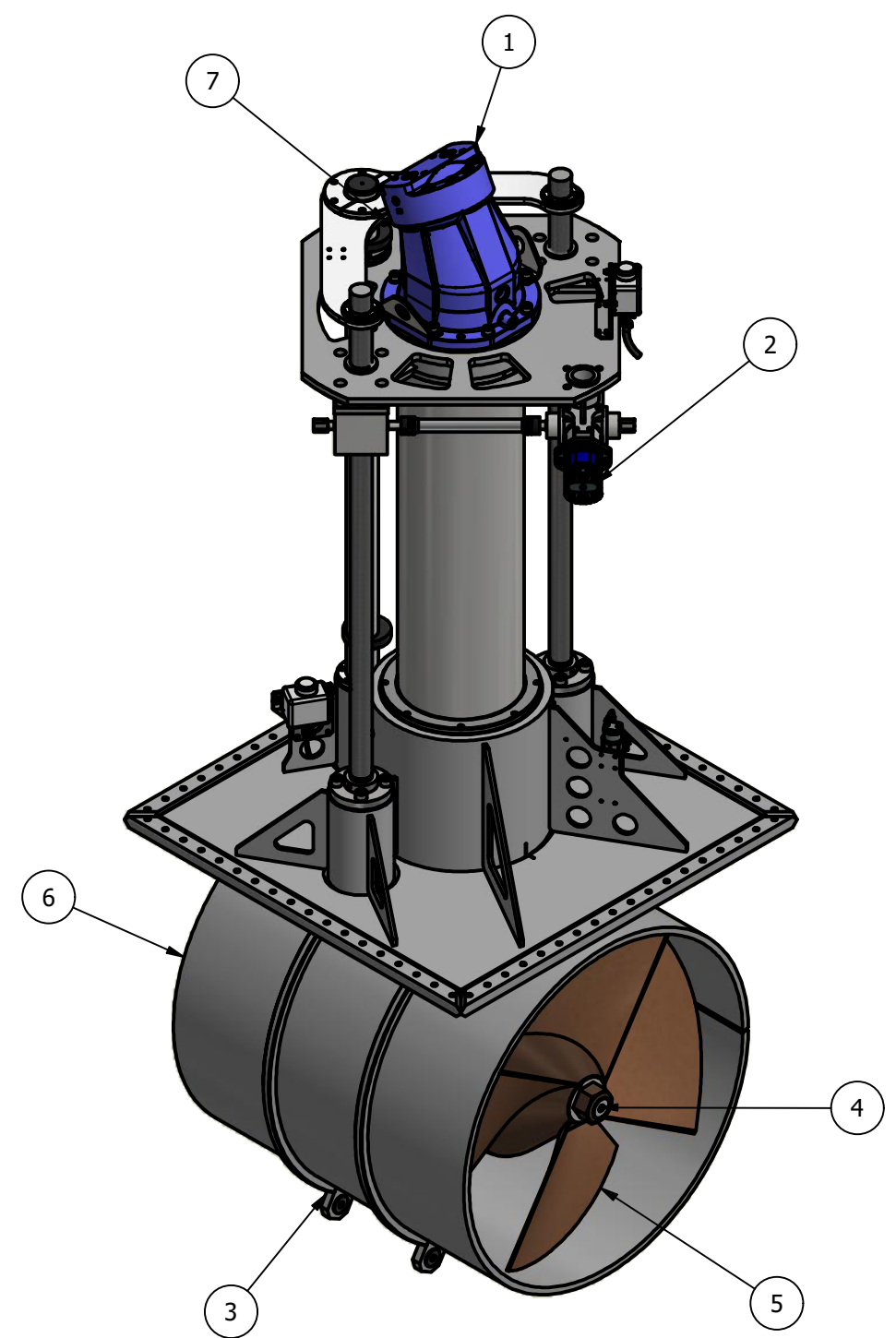

ITEM	QTY	DESCRIPTION
1	1	HYDRAULIC MAIN DRIVE MOTOR
2	1	HYDRAULIC LIFT MECHANISM
3	1	TUNNEL ASSEMBLY
4	1	POD ASSEMBLY
5	1	PROPELLER 1
6	1	PROPELLER 2
7	2	PROXIMITY SENSOR

NOMINAL PROP DIA	1200mm
POWER RANGE	393-565Kw (527-758hp)
MIN / MAX THRUST	4323-6215kgf (9506-13702lbf)
WEIGHT APPROXIMATELY	3350kg (7385lb)
STANDARD PRESSURE	350 Bar
NOMINAL FLOW	1070 L/min

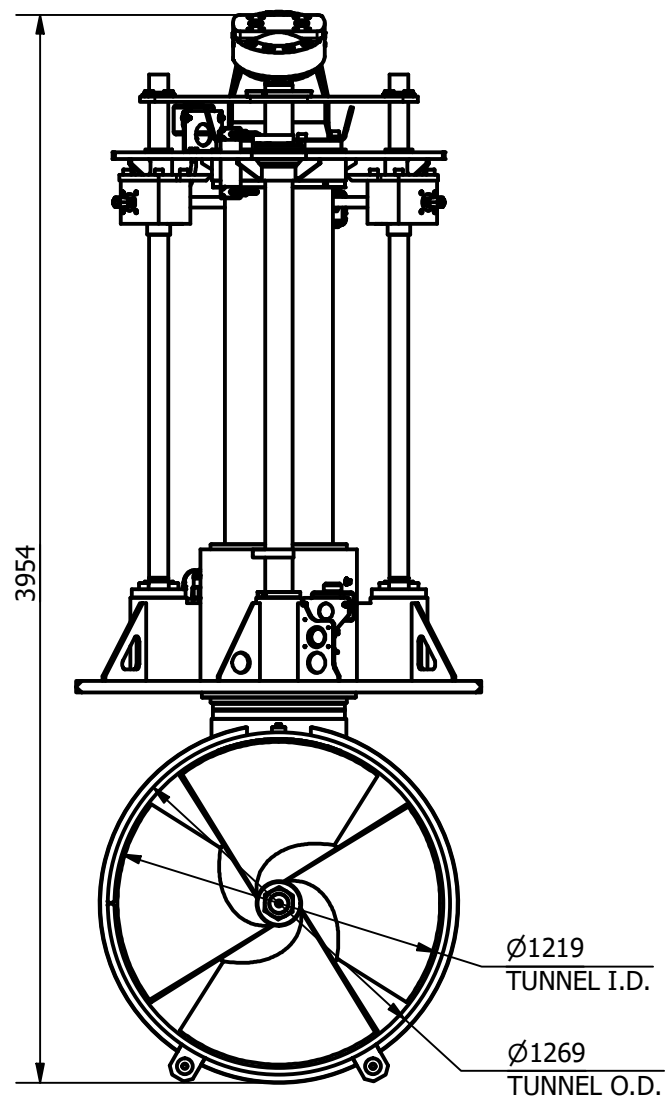
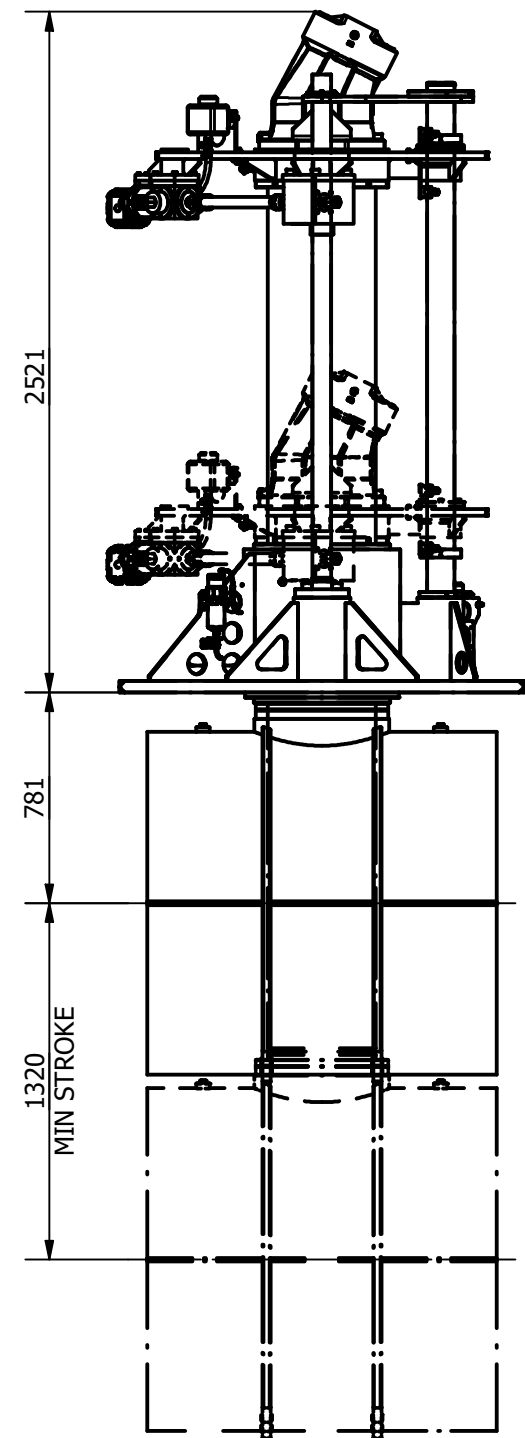
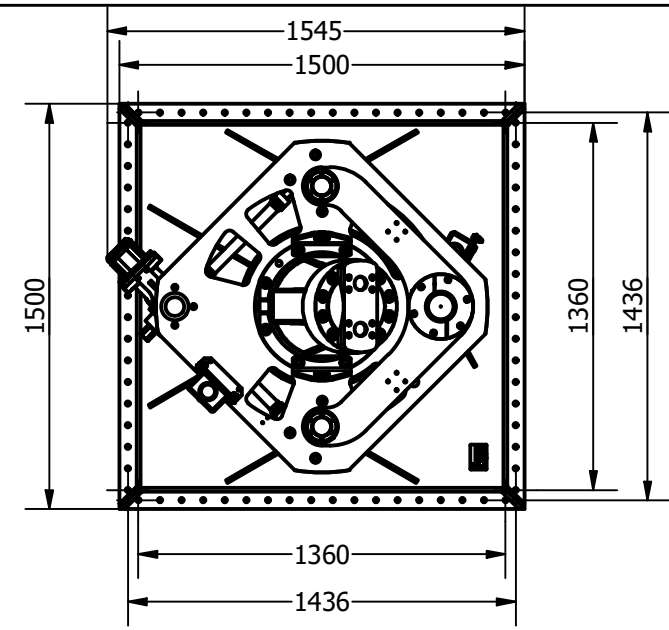

 Tel: +44 (0)1202 596600 www.oceanyachtsystems.co.uk	Title VERTICAL RETRACT THRUSTER - HYDRAULIC				Revision 2		Dimensions in millimeters & degrees Gen. Tolerance ± 0.2 Gen. Finish 3.2 ✓		
	Drawing No. H-1200-V		Material		Finish		If in doubt ask!		
Sheet 1 of 1	Scale NTS @ A3	Mass N/A	Date Drawn 18/03/2020	By CR	Modified Date	By	Cert. Y	Insp. III	Grade A

© Copyright. All rights to this drawing and design are the sole property of Ocean Yacht Systems Ltd. This drawing must not be copied, communicated or loaned to any third party without the written consent of Ocean Yacht Systems Ltd.