

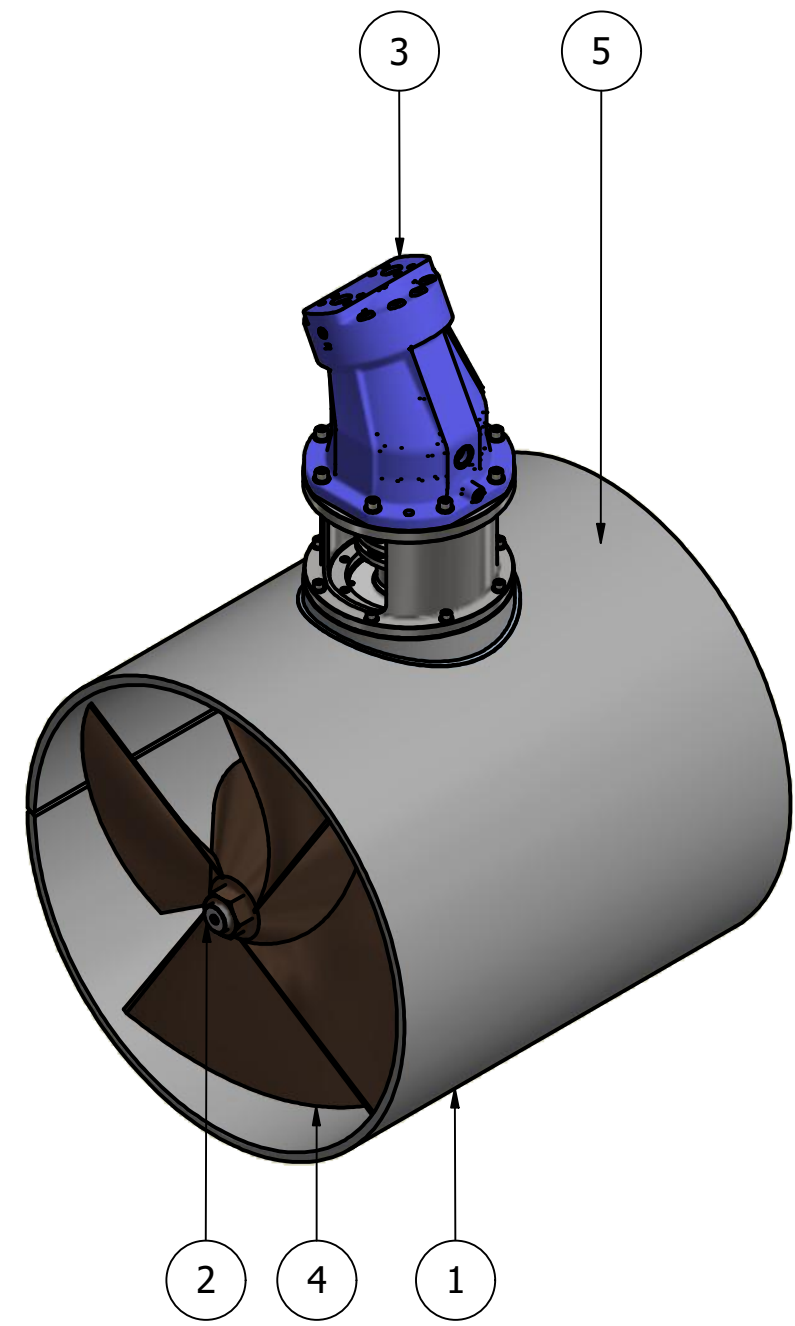

ITEM	QTY	PART NUMBER
1	1	TUNNEL ASSEMBLY
2	1	POD ASSEMBLY
3	1	MOTOR ASSEMBLY
4	1	PROPELLER 1
5	1	PROPELLER 2

NOMINAL PROP DIA	1200mm
POWER RANGE	393-565Kw (527-758hp)
MIN / MAX THRUST	4323-6215kgf (9531-13702lbf)
WEIGHT APPROXIMATELY (EXCL TUNNEL)	1774kg (3911lb)
STANDARD PRESSURE	350 BAR
NOMINAL FLOW	1070 L/min

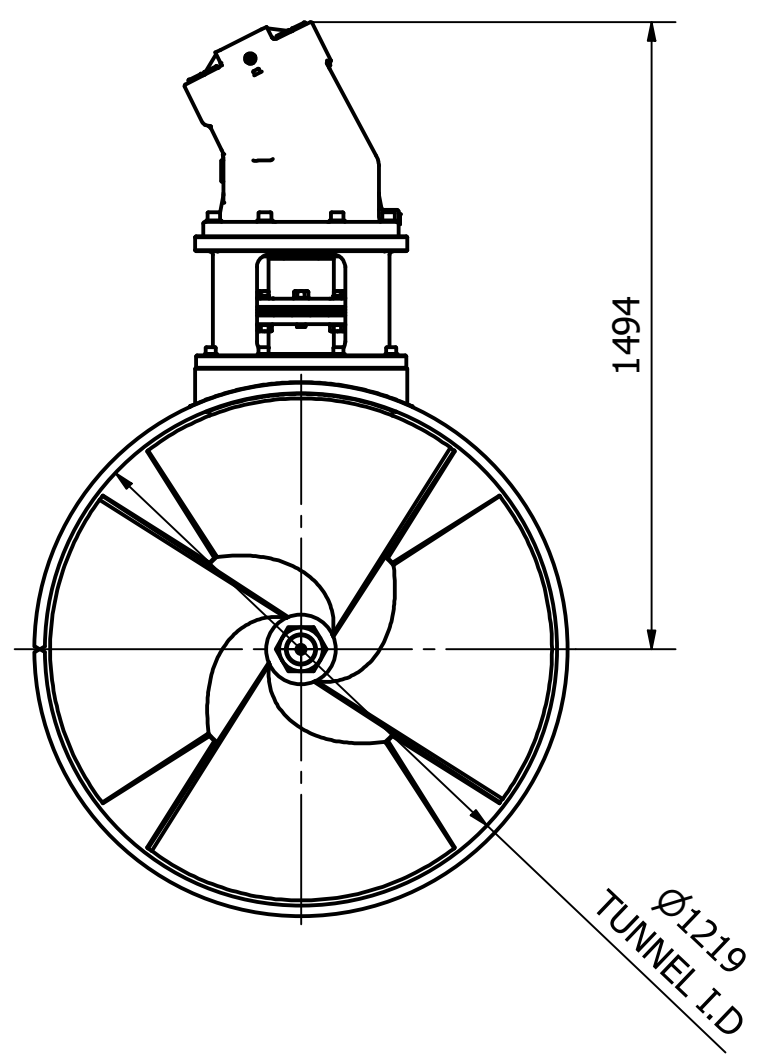
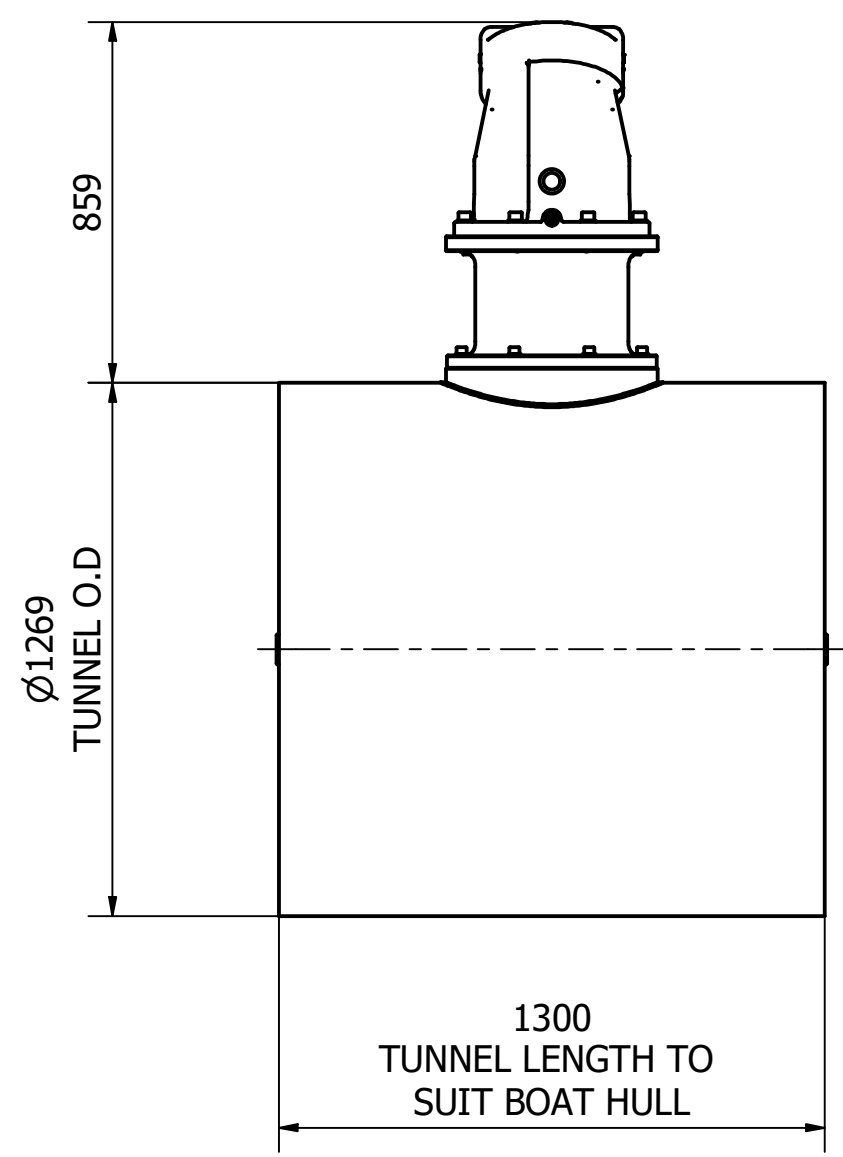

 Tel: +44 (0)1202 596600 www.oceanyachtsystems.co.uk	Title TUNNEL THRUSTER - HYDRAULIC			Revision 1	Dimensions in millimeters & degrees			
	Drawing No. H-1200-T		Material	Finish	Gen. Tolerance ± 0.2			
	Sheet 1 of 1	Scale NTS @ A3	Mass N/A	Date Drawn 04/03/2020	By JG	Modified Date	By	Gen. Finish 3.2 ✓
								 If in doubt ask!
			Cert.	Insp.	Grade			