

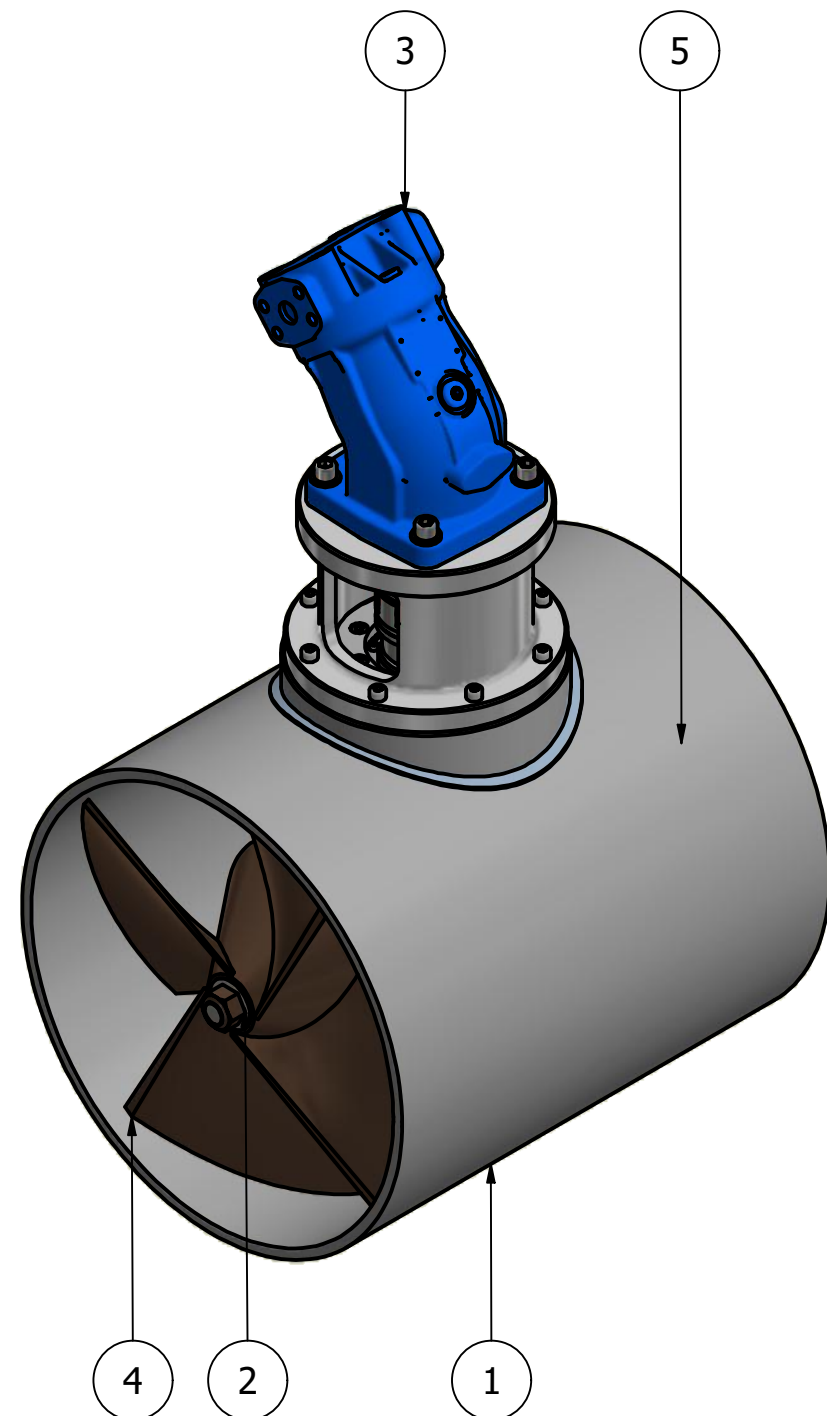

ITEM	QTY	PART NUMBER
1	1	TUNNEL ASSEMBLY
2	1	POD ASSEMBLY
3	1	MOTOR ASSEMBLY
4	1	PROPELLER 1
5	1	PROPELLER 2

NOMINAL PROP DIA	400mm
POWER RANGE	36-63Kw (48-85hp)
MIN / MAX THRUST	432-756kgf (952-1667lbf)
WEIGHT APPROXIMATELY (EXCL TUNNEL)	114kg (251lb)
STANDARD PRESSURE	250 BAR
NOMINAL FLOW	168 L/min

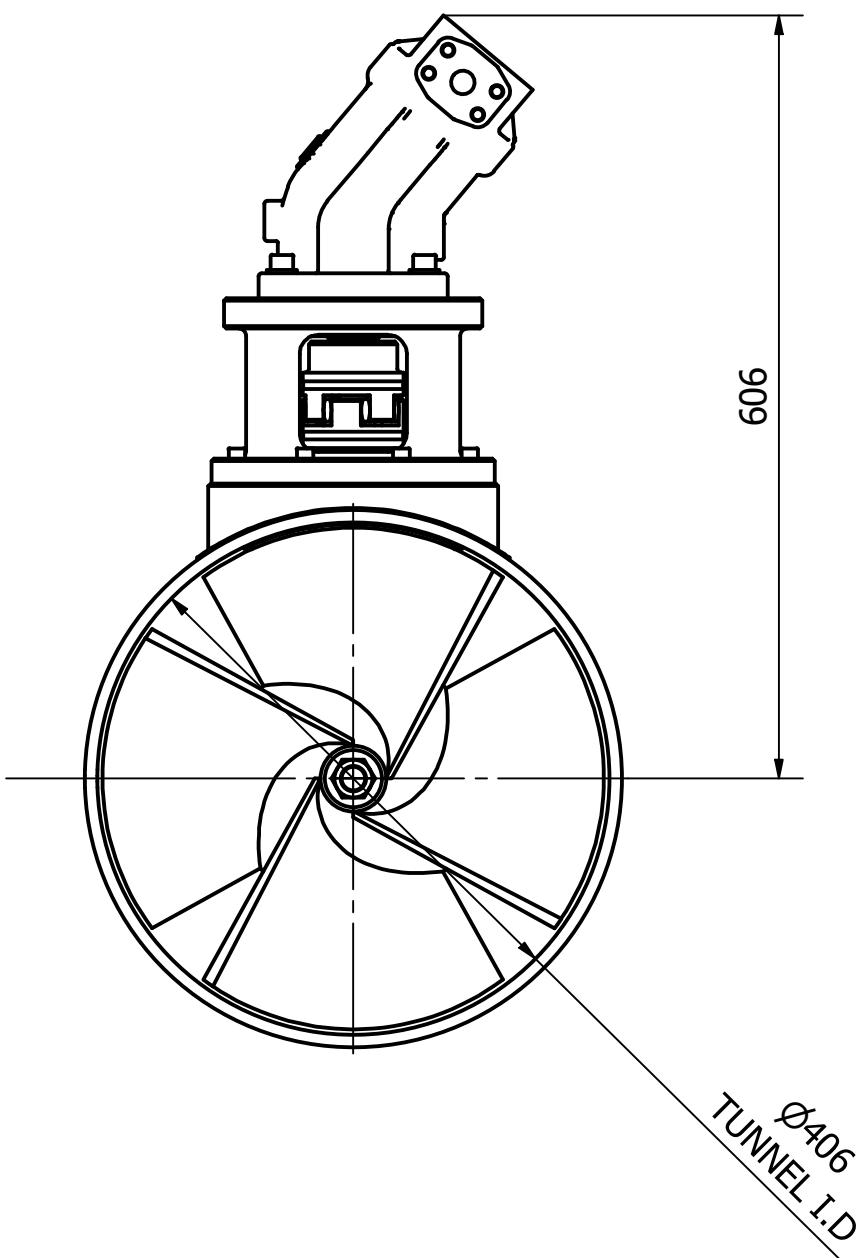
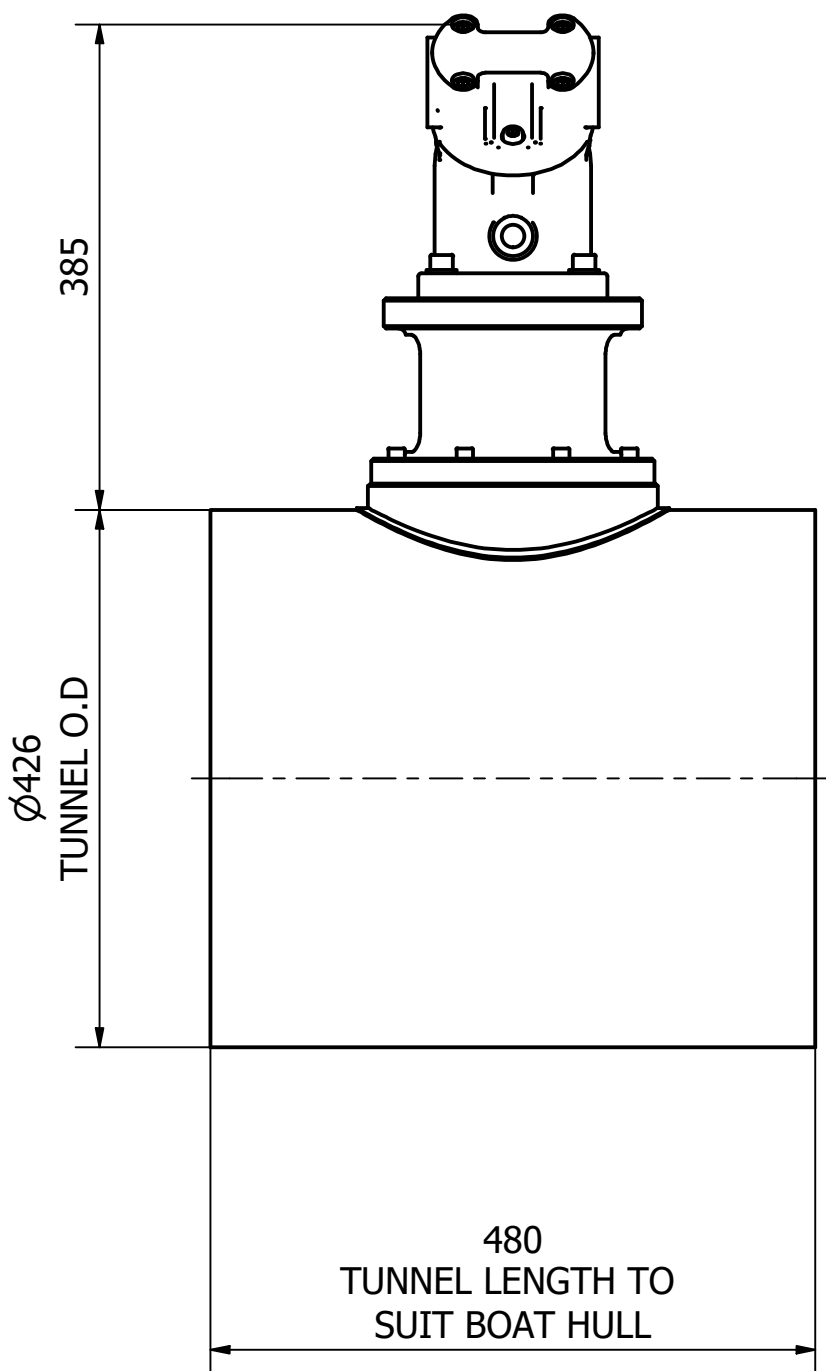

 Tel: +44 (0)1202 596600 www.oceanyachtsystems.co.uk	Title TUNNEL THRUSTER - HYDRAULIC		Revision 1	Dimensions in millimeters & degrees Gen. Tolerance ± 0.2 Gen. Finish 3.2 ✓  If in doubt ask!					
	Drawing No. H-0400-T	Material	Finish						
Sheet 1 of 1	Scale NTS @ A3	Mass N/A	Date Drawn 03/03/2020	By JG	Modified Date	By	Cert.	Insp.	Grade