

SIZE -0150
 PCLC 1166 mm
 PIN / GAP 44.45 mm
 BORE DIA 135 mm
 ROD DIA 50 mm
 STROKE 475 mm
 WEIGHT 120.24 Kg
 FULL BORE AREA (PUSHING/EXTENDING) 14314 mm²
 ANNULUS AREA (PULLING/RETRACTING) 12350 mm²
 GAS DISPLACEMENT (FULL BORE SIDE) 6.80 ltrs
 OIL DISPLACEMENT (ANNULUS SIDE) 5.87 ltrs
 MAXIMUM PUSH FORCE @ 5 BAR 730 Kg (7157 N)
 PULL FORCE @ 150 BAR 18884 Kg (185256 N)
 PULL FORCE @ 250 BAR 31474 Kg (308760 N)
 MAX PULL FORCE @ 350 BAR (RELIEF) 44064 Kg (432264 N)

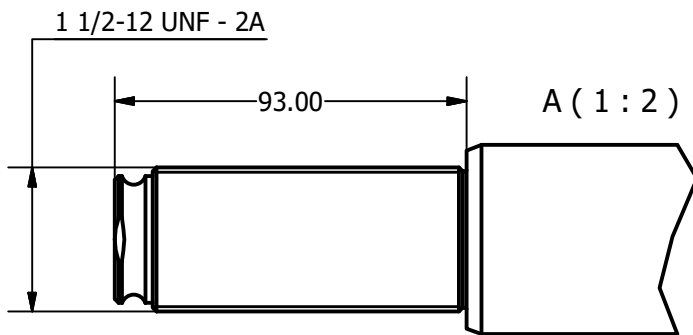
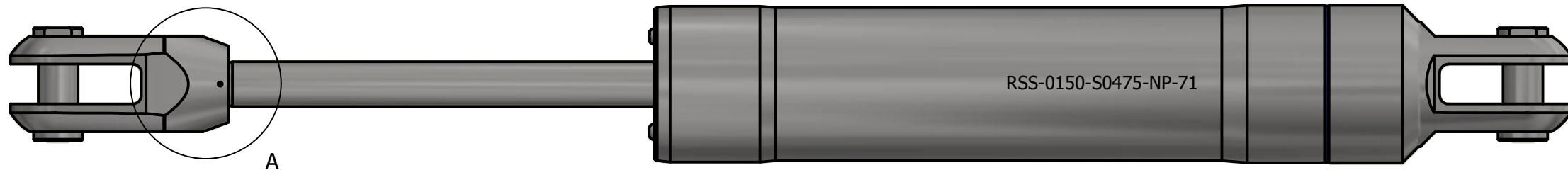
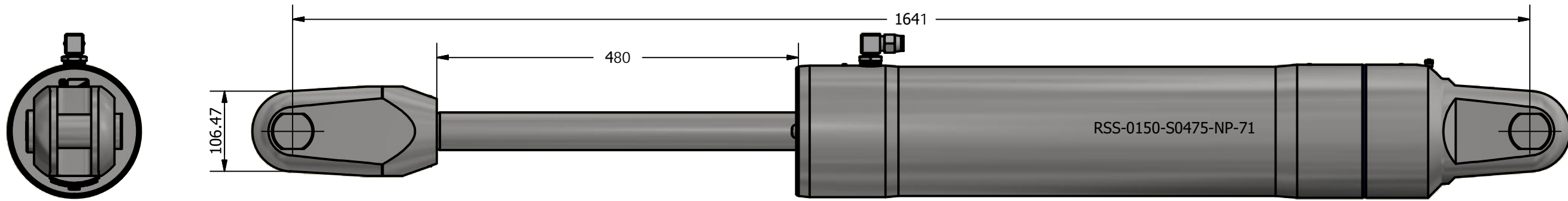
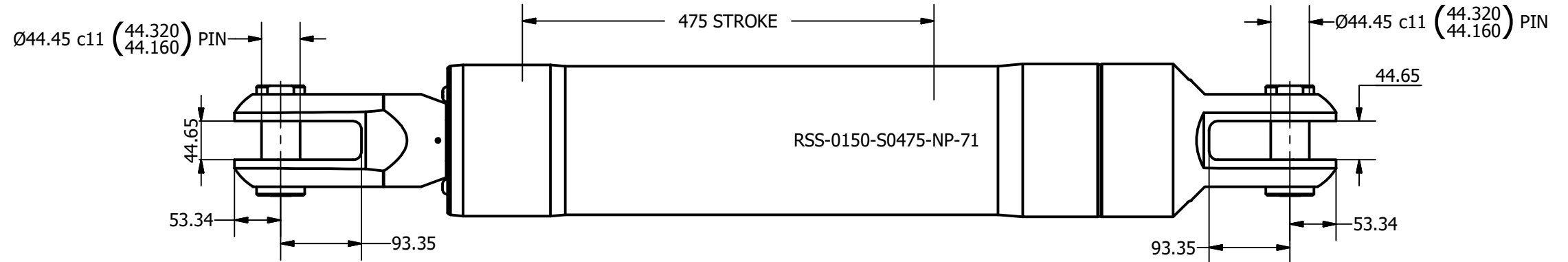
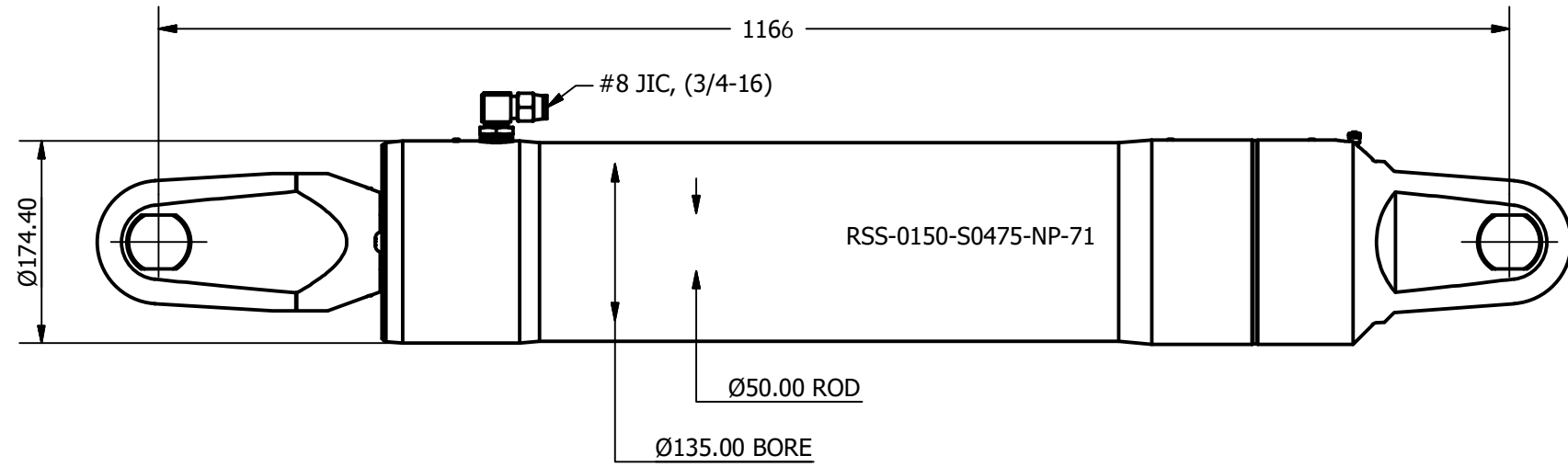

NOTE: CUSTOM STROKES, LENGTHS AND CLEVIS DIMENSIONS AVAILABLE UPON REQUEST

	Title STAINLESS SINGLE ACTING GAS RETURN CYLINDER		Revision 2
	Drawing No. RSS-0150-S0475-NP-71		Date Drawn By 10/11/2021 AL
	Tel: +44 (0)1202 596630 www.oms.ltd		© Copyright. All rights to this drawing and design are the sole property of OMS Ltd. This drawing must not be copied, communicated or loaned to any third party without the written consent of OMS Ltd.