

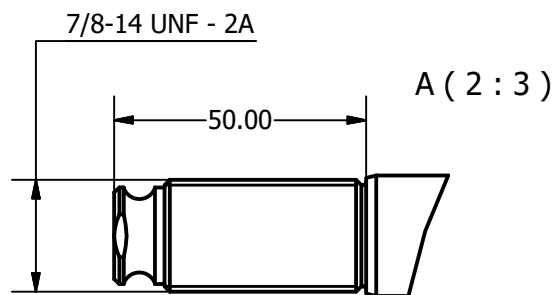

SIZE	-0030
PCLC	1395 mm
PIN / GAP	22.23 mm
BORE DIA	65 mm
ROD DIA	24 mm
STROKE	1025 mm
WEIGHT	13.47 Kg
FULL BORE AREA (PUSHING/EXTENDING)	3318 mm ²
ANNULUS AREA (PULLING/RETRACTING)	2866 mm ²
OIL DISPLACEMENT (FULL BORE SIDE)	3.40 ltrs
OIL DISPLACEMENT (ANNULUS SIDE)	2.94 ltrs
MAXIMUM PUSH FORCE @ 4 BAR	135 Kg (1327 N)
PULL FORCE @ 150 BAR	4382 Kg (42989 N)
PULL FORCE @ 250 BAR	7304 Kg (71648 N)
MAX PULL FORCE @ 350 BAR (RELIEF)	10225 Kg (100307 N)

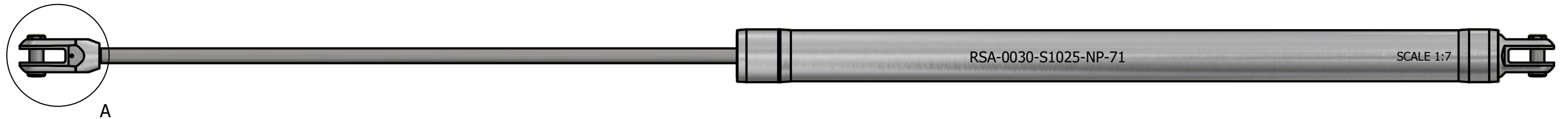
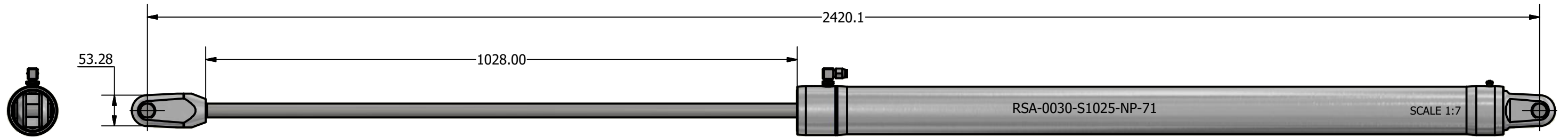
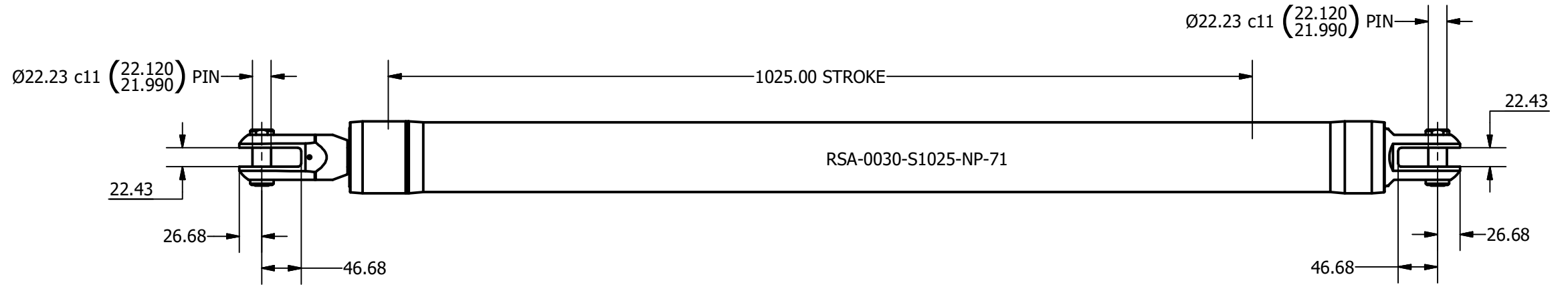
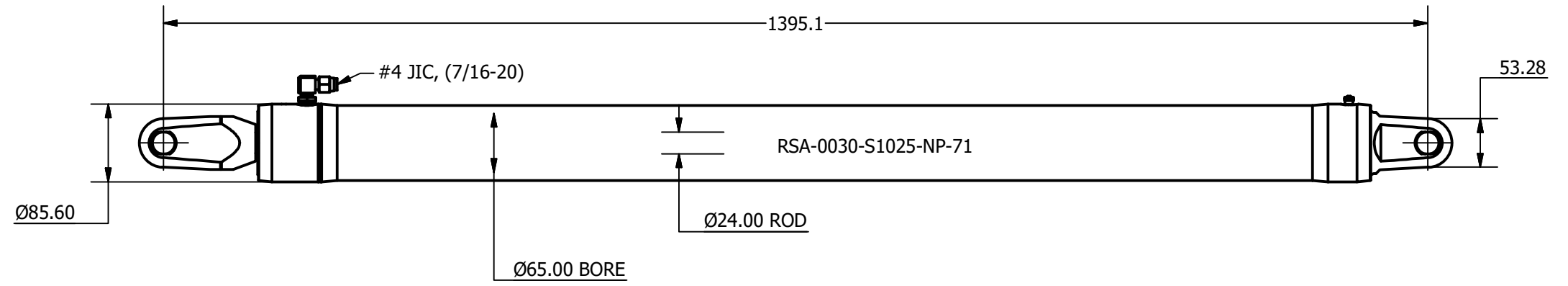
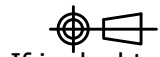

NOTE: CUSTOM STROKES, LENGTHS AND CLEVIS DIMENSIONS AVAILABLE UPON REQUEST

 Tel: +44 (0)1202 596600 www.oceanyachtsystems.co.uk	Title ALUMINIUM SINGLE ACTING GAS RETURN CYLINDER (LONG)		Revision 2	Dimensions in millimeters & degrees Gen. Tolerance ± 0.25 Gen. Finish 3.2			
	Drawing No. RSA-0030-S1025-NP-71		Material	Finish AS MACHINED		 If in doubt ask!	
	Sheet 1 of 1	Scale 1:6 @ A3	Mass N/A	Date Drawn 17/09/2017	By A.N.		Modified Date
	Mat. Cert.		Insp. Lev. III	Fin. Lev. A			