

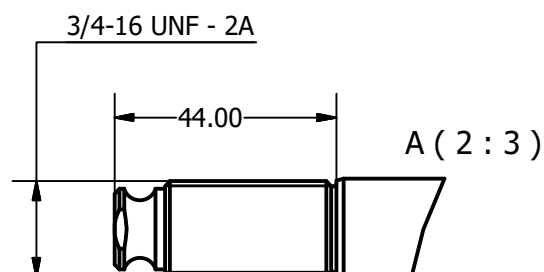

SIZE	-0022
PCLC	691 mm
PIN / GAP	19.05 mm
BORE DIA	56 mm
ROD DIA	20 mm
STROKE	400 mm
WEIGHT	5.15 Kg
FULL BORE AREA (PUSHING/EXTENDING)	2463 mm ²
ANNULUS AREA (PULLING/RETRACTING)	2149 mm ²
OIL DISPLACEMENT (FULL BORE SIDE)	0.99 ltrs
OIL DISPLACEMENT (ANNULUS SIDE)	0.86 ltrs
MAXIMUM PUSH FORCE @ 5 BAR	126 Kg (1232 N)
PULL FORCE @ 150 BAR	3286 Kg (32233 N)
PULL FORCE @ 250 BAR	5479 Kg (53721 N)
MAX PULL FORCE @ 350 BAR (RELIEF)	7667 Kg (75210 N)

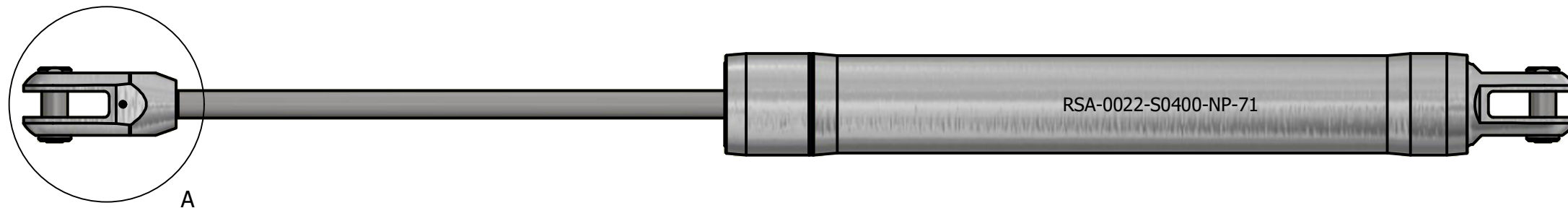
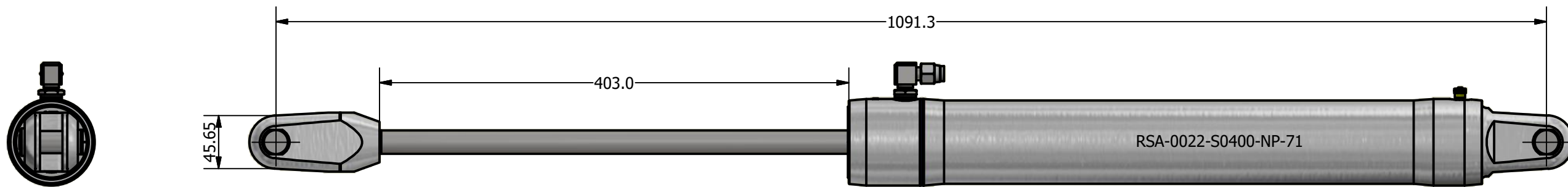
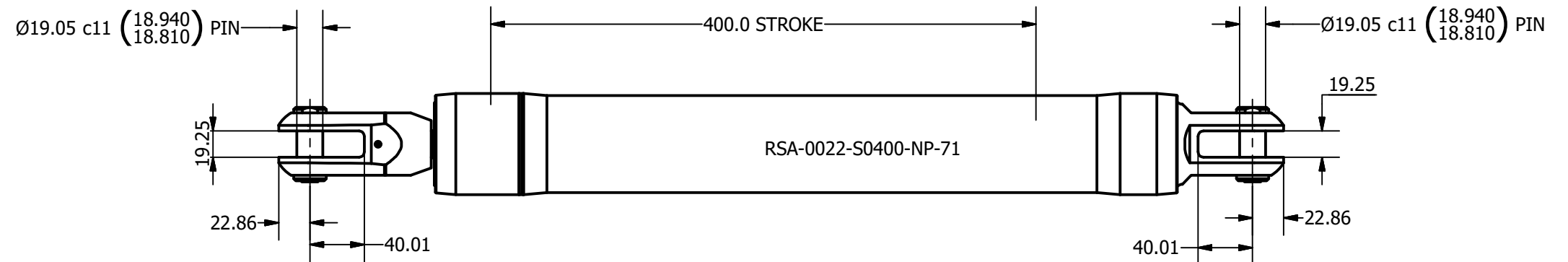
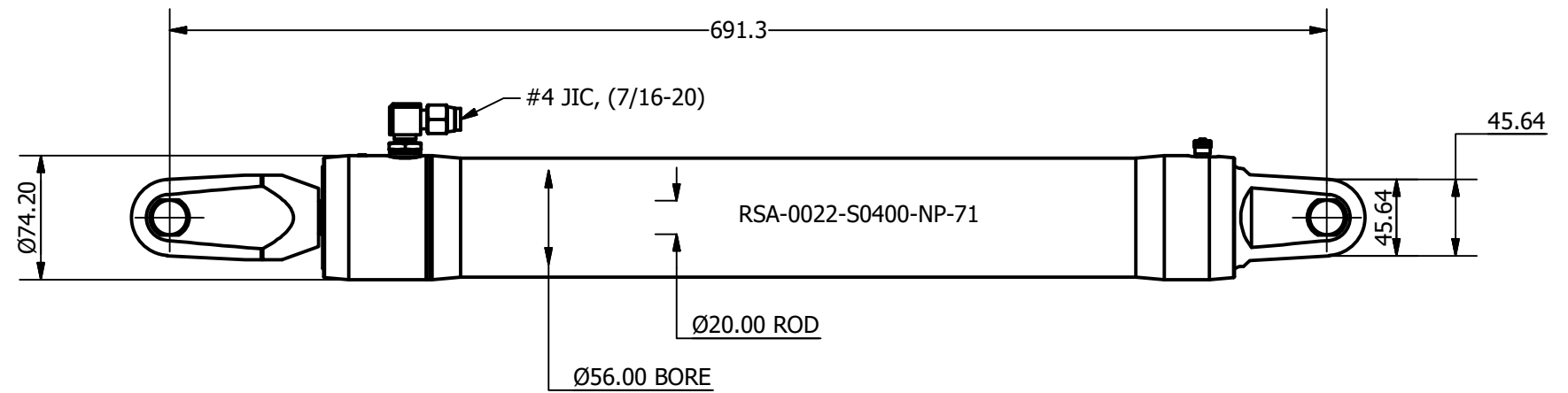
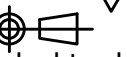

NOTE: CUSTOM STROKES, LENGTHS AND CLEVIS DIMENSIONS AVAILABLE UPON REQUEST

 Tel: +44 (0)1202 596600 www.oceanyachtsystems.co.uk	Title ALUMINIUM SINGLE ACTING GAS RETURN CYLINDER			Revision A		Dimensions in millimeters & degrees Gen. Tolerance ± 0.25 Gen. Finish 3.2		
	Drawing No. RSA-0022-S0400-NP-71		Material		Finish BLACK ANODISED			 If in doubt ask!
	Sheet 1 of 1	Scale 1:4 @ A3	Mass N/A	Date Drawn 01/10/2017	By A.N.	Modified Date	By	
	© Copyright. All rights to this drawing and design are the sole property of Ocean Yacht Systems Ltd. This drawing must not be copied, communicated or loaned to any third party without the written consent of Ocean Yacht Systems Ltd.			Mat. Cert.	Insp. Lev. III	Fin. Lev. A		