

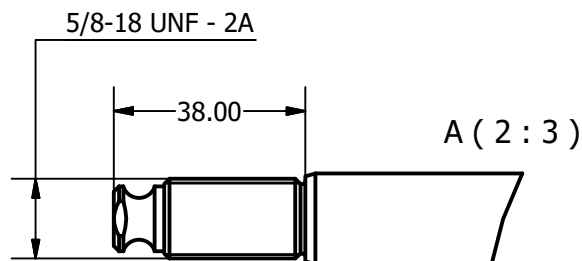

SIZE	-0017
PCLC	518 mm
PIN / GAP	15.88 mm
BORE DIA	46 mm
ROD DIA	18 mm
STROKE	260 mm
WEIGHT	2.65 Kg
FULL BORE AREA (PUSHING/EXTENDING)	1662 mm ²
ANNULUS AREA (PULLING/RETRACTING)	1407 mm ²
OIL DISPLACEMENT (FULL BORE SIDE)	0.43 ltrs
OIL DISPLACEMENT (ANNULUS SIDE)	0.37 ltrs
MAXIMUM PUSH FORCE @ 5 BAR	85 Kg (831 N)
PULL FORCE @ 150 BAR	2152 Kg (21112 N)
PULL FORCE @ 250 BAR	3587 Kg (35186 N)
MAX PULL FORCE @ 350 BAR (RELIEF)	5021 Kg (49260 N)

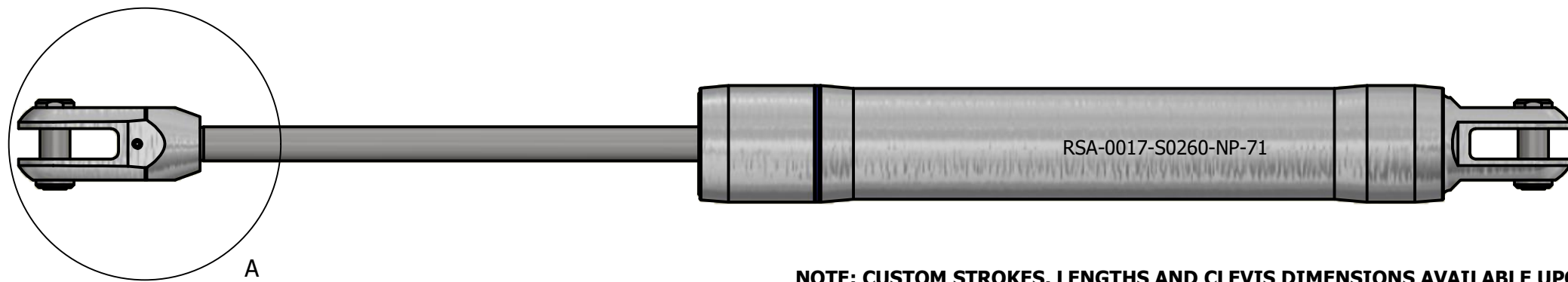
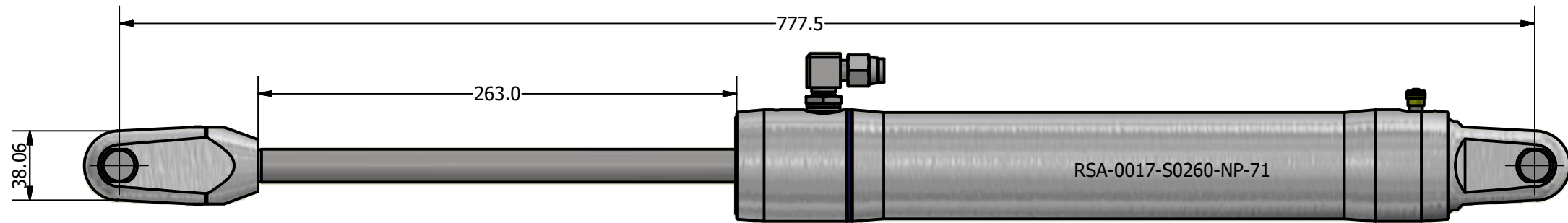
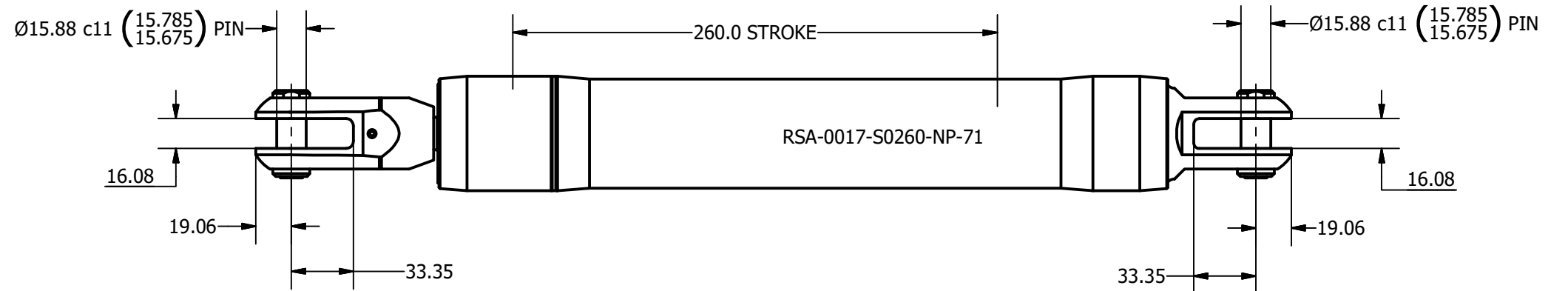
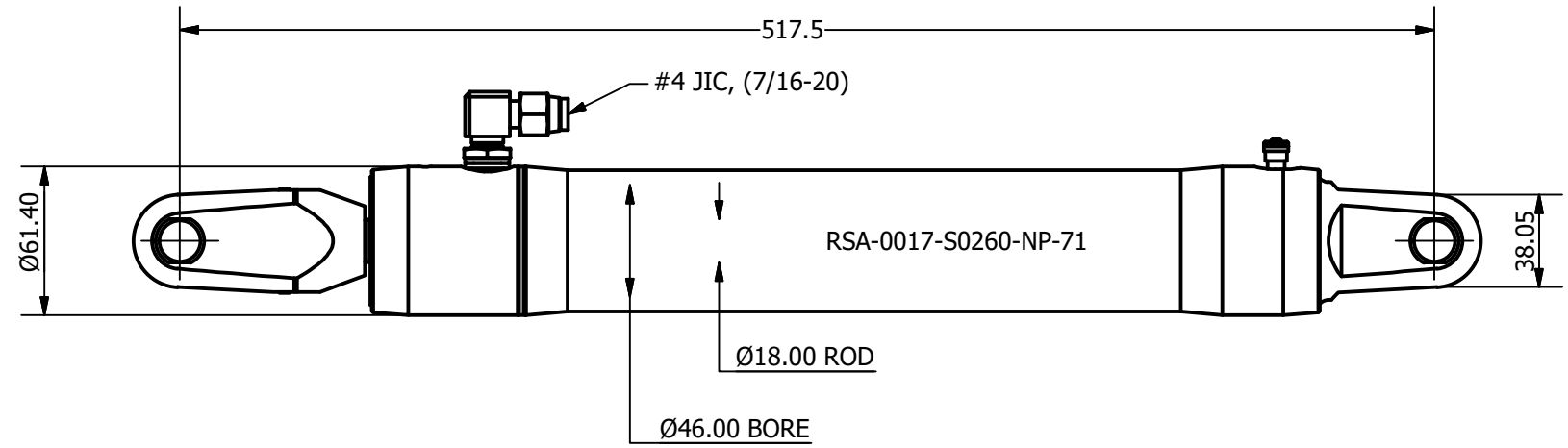
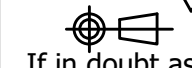

NOTE: CUSTOM STROKES, LENGTHS AND CLEVIS DIMENSIONS AVAILABLE UPON REQUEST

 Tel: +44 (0)1202 596600 www.oceanyachtsystems.co.uk	Title ALUMINIUM SINGLE ACTING GAS RETURN CYLINDER			Revision 2	Dimensions in millimeters & degrees Gen. Tolerance ± 0.25 Gen. Finish 3.2		
	Drawing No. RSA-0017-S0260-NP-71		Material	Finish AS MACHINED		 If in doubt ask!	
	Sheet 1 of 3	Scale 1:2 @ A3	Mass N/A	Date Drawn 14/06/2017	By A.N.		
	Mat. Cert.		Insp. Lev. III	Fin. Lev. A			