

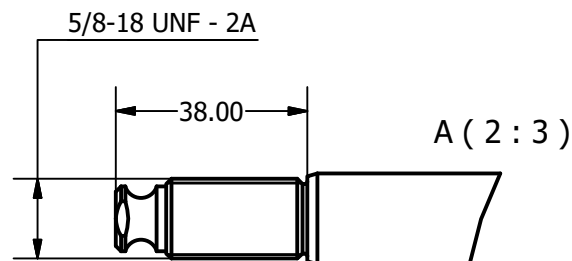

SIZE	-0012
PCLC	508 mm
PIN / GAP	15.88 mm
BORE DIA	40 mm
ROD DIA	18 mm
STROKE	260 mm
WEIGHT	2.2 Kg
FULL BORE AREA (PUSHING/EXTENDING)	1257 mm ²
ANNULUS AREA (PULLING/RETRACTING)	1002 mm ²
OIL DISPLACEMENT (FULL BORE SIDE)	0.33 ltrs
OIL DISPLACEMENT (ANNULUS SIDE)	0.26 ltrs
MAXIMUM PUSH FORCE @ 5 BAR	64 Kg (628 N)
PULL FORCE @ 150 BAR	1532 Kg (15033 N)
PULL FORCE @ 250 BAR	2554 Kg (25054 N)
MAX PULL FORCE @ 350 BAR (RELIEF)	3576 Kg (35076 N)

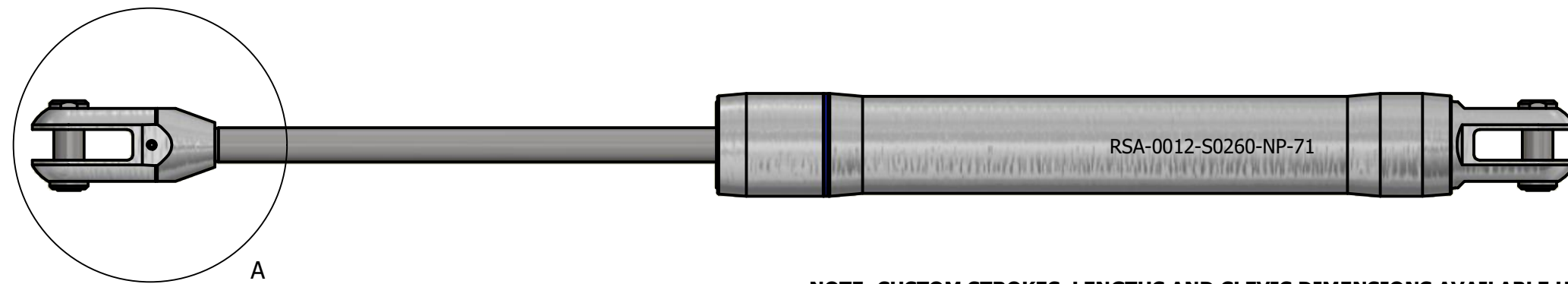
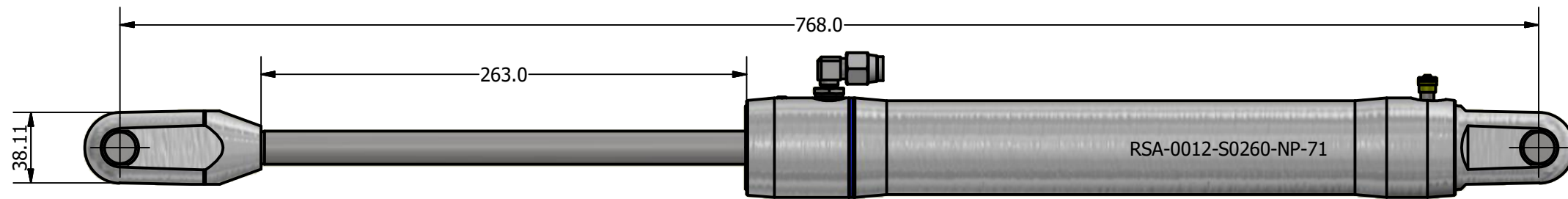
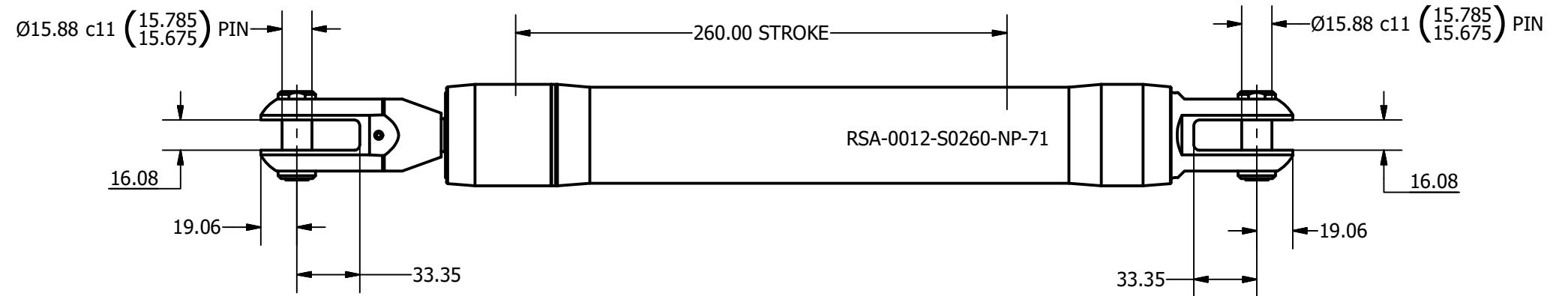
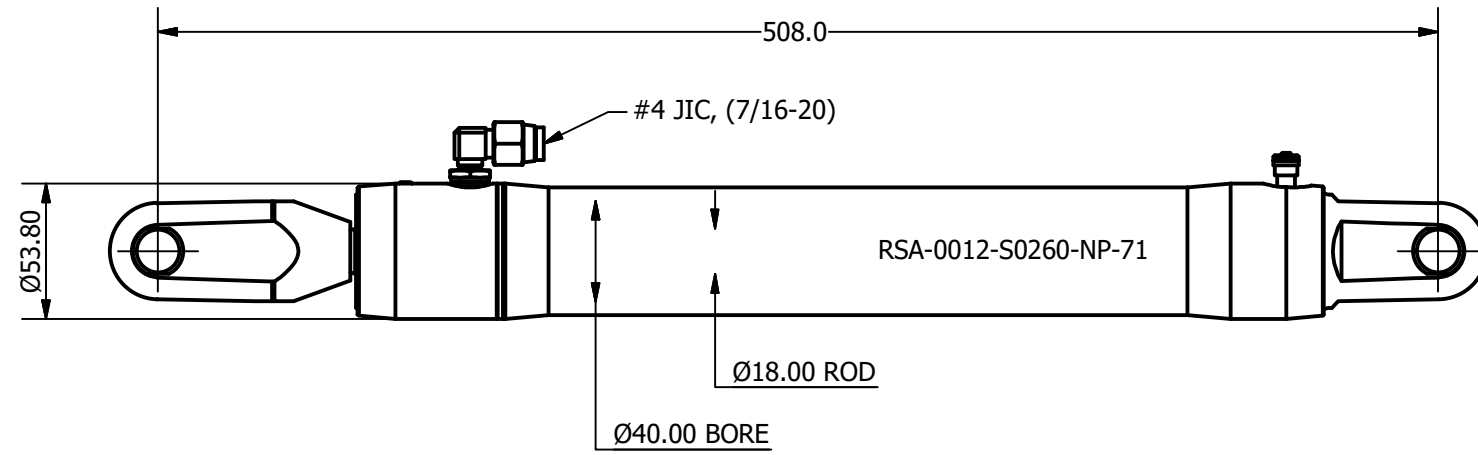
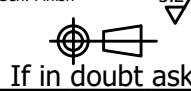

NOTE: CUSTOM STROKES, LENGTHS AND CLEVIS DIMENSIONS AVAILABLE UPON REQUEST

 Tel: +44 (0)1202 596600 www.oceanyachtsystems.co.uk	Title ALUMINIUM SINGLE ACTING GAS RETURN CYLINDER			Revision 1	Dimensions in millimeters & degrees Gen. Tolerance ± 0.25 Gen. Finish 3.2		
	Drawing No. RSA-0012-S0260-NP-71		Material	Finish AS MACHINED		 If in doubt ask!	
	Sheet 1 of 1	Scale 1:3 @ A3	Mass N/A	Date Drawn 14/06/2017	By A.N.		
	Modified Date		By		Mat. Cert.	Insp. Lev. III	Fin. Lev. A